

THE SLIDING SCREEN DOOR

by **SCREENEZE**

INSTALLATION INSTRUCTIONS

★ ★ ★ READ INSTRUCTIONS FROM BEGINNING TO END BEFORE INSTALLATION

DESIGNED FOR A 36" X 80½" FINISHED OPENING
ASSEMBLED DOOR IS 38" X 83"

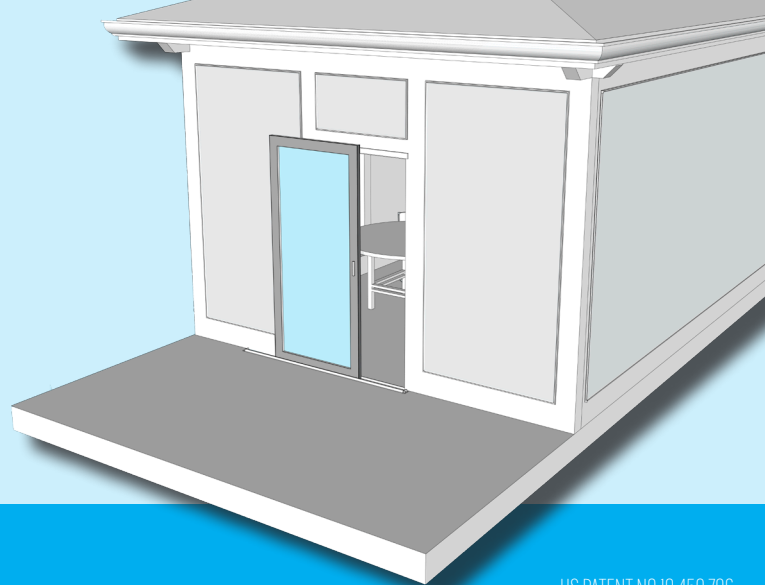

US PATENT NO 10,450,796

IDENTIFY PARTS

- Utilize a solid 4' x 8' level surface for assembly.
- Cover surface with cloth/cardboard to protect powder coating from scratches.
- Remove all contents of the package and identify parts.
- Place the stiles and rails with the flat/smooth surface down.
- The stiles and rails are pre-cut and pre-drilled.
- Identify the pre-drilled rail for the glide - this is the top of your door.
- Corner keys are installed on stiles for accuracy.

SCAN TO WATCH
INSTALL OVERVIEW

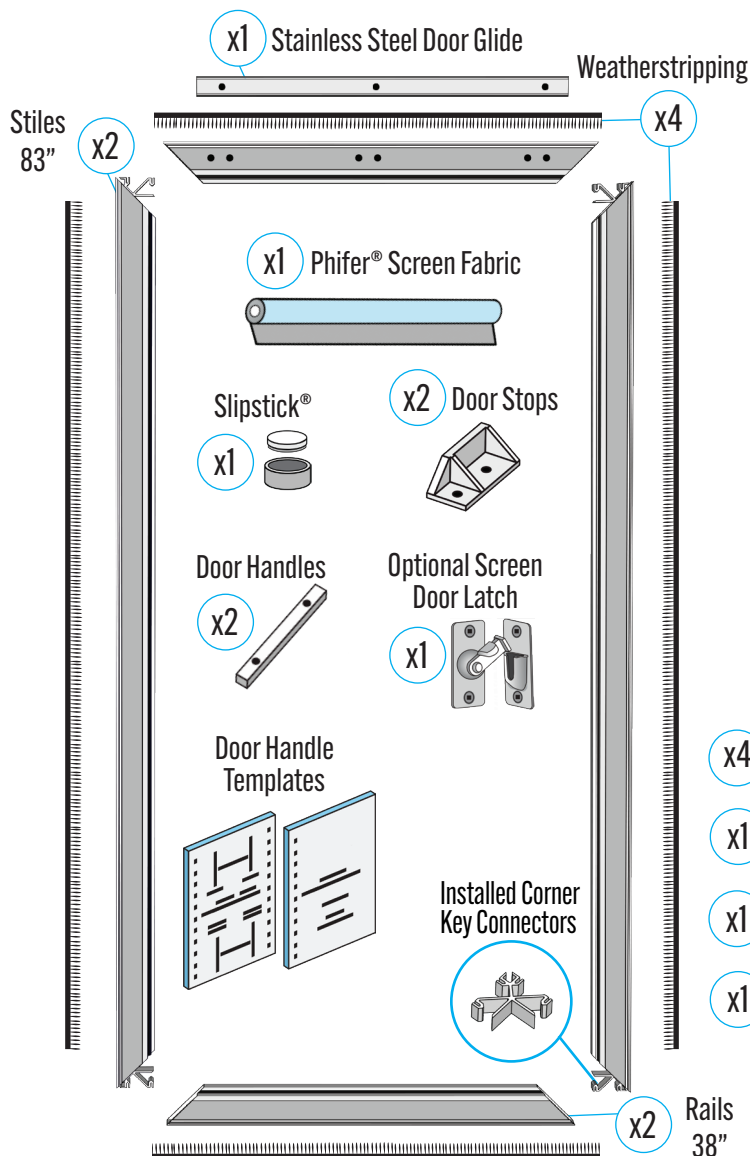

SCREW CHART

- x8 ½" SQUARE DRIVE COLOR MATCHED TEK SCREWS
8 - SECURING CORNER KEYS + SLIPSTICK® GLIDE | STEPS 4 & 5
- x7 ½" SQUARE DRIVE STAINLESS STEEL TEK SCREWS
3 - SECURING BALL BEARING GLIDE TO DOOR RAIL | STEP 10
4 - SECURING OPTIONAL LATCH | STEP 18
- x15 1¼" SQUARE DRIVE SELF TAPPING COLOR MATCHED SCREWS
3 - ATTACHING 36" THRESHOLD | STEP 13
3 - ATTACHING 70" THRESHOLD | STEP 15
4 - ATTACHING TWO DOOR STOPS | STEP 16
4 - ATTACHING TWO DOOR HANDLES | STEP 17
- x3 1" SQUARE DRIVE STAINLESS STEEL TEK SCREW
3 - ATTACHING GLIDE BASE TO DOOR HEADER | STEP 12

- x4 SCREENEZE® Vinyl Caps
- x1 70" Threshold
- x1 36" Threshold
- x1 Self Sticking Weatherstripping

TOOLS NEEDED FOR INSTALLATION

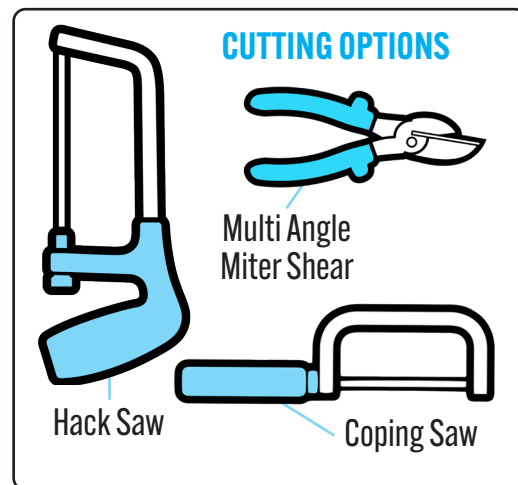
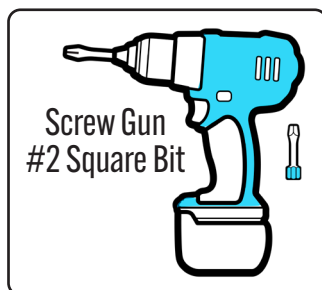
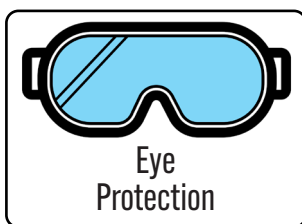
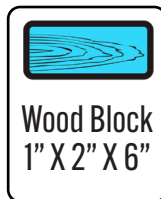
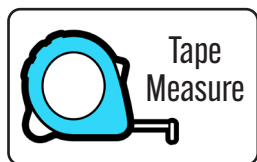
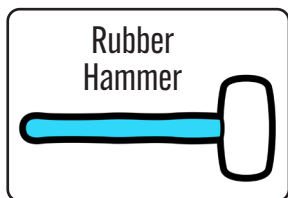
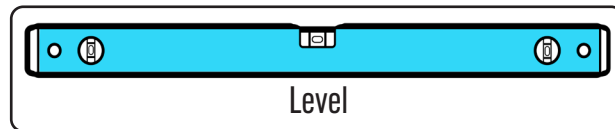
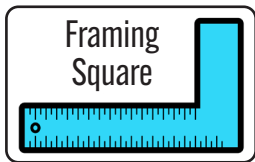

PREPARE OPENING FOR INSTALL

- Finished door opening measurements should measure 36" x 80 1/2".
- Ensure vertical and horizontal elements are level with a flush surface.

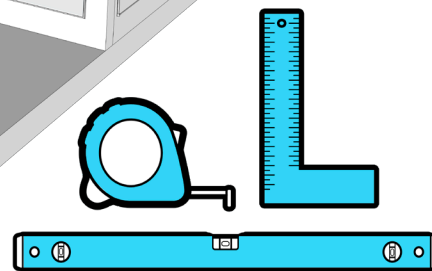
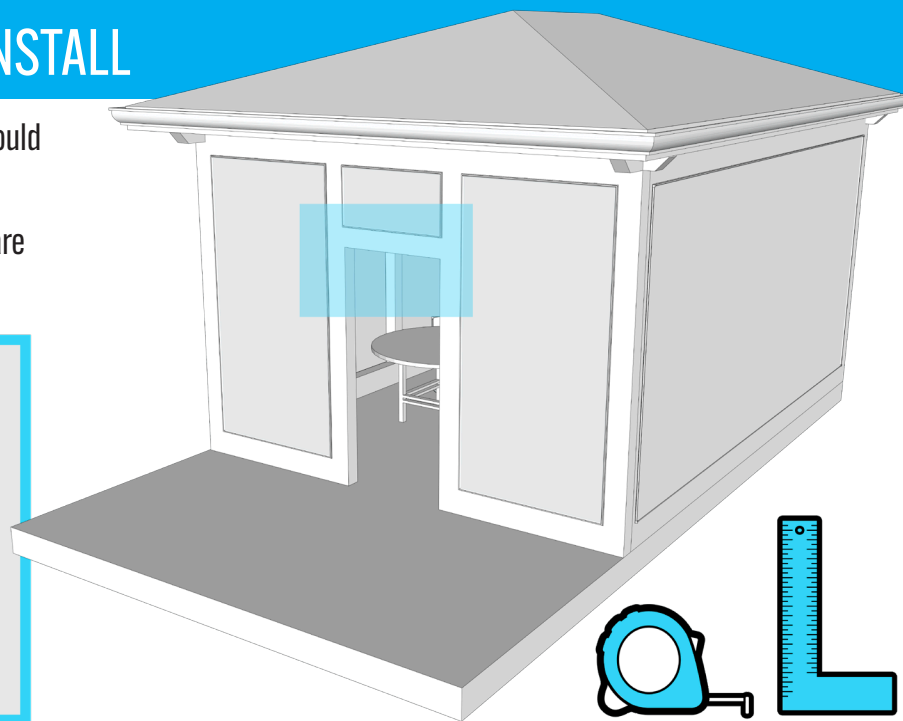
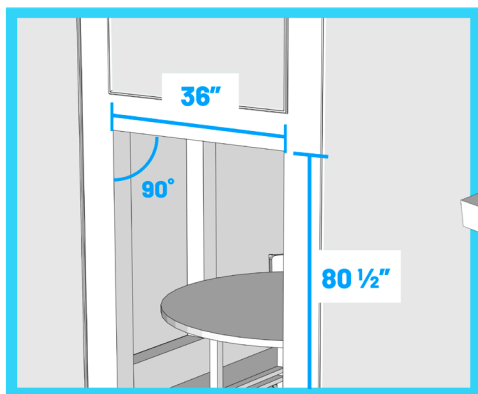

- Determine glide path - left glide or right glide (step 3).
- Door installation requires a clear glide path of an additional 32" to the left or right for interior or exterior install.
- For best results, use 3" framing for the door opening (minimum 2").
- Door opening needs to be plumb and level in the wall and with the floor.
- The framing is critical. It will be the base/face for the weatherstripping on the door.
- If the wall is more than 1/4" out of plumb, the door will not work as intended.
- Door threshold will compensate for up to 3/4" if the floor is not level.

STEP 1: LAYOUT STILES & RAILS

Layout stiles and rails on your solid level work surface.

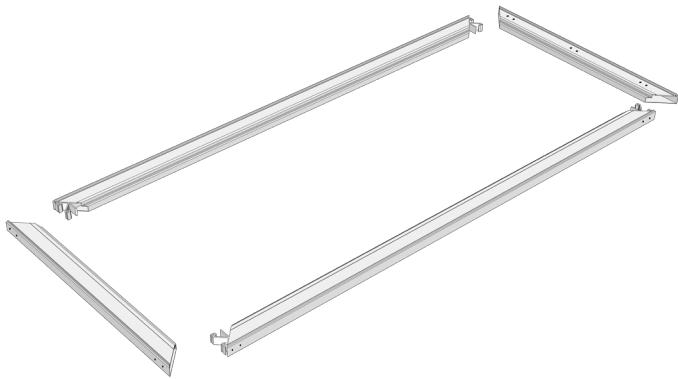

STEP 2: INSTALL WEATHERSTRIPPING

Install by sliding the four pieces of weatherstripping into the slots/grooves on stiles and rails. Trim each end at a 45 degree angle. Leave an extra 1/8" of excess at each end.

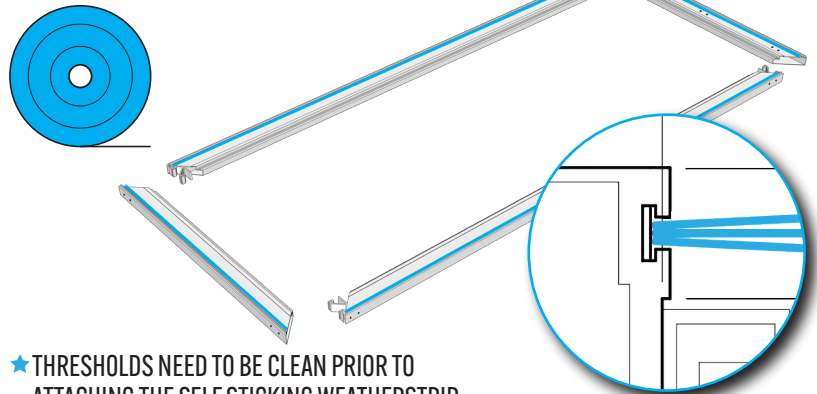

STEP 3: DETERMINE GLIDE PATH

Determine if your door will be installed on the interior or exterior of the opening and if it will glide left or glide right. Since the door requires a glide path of an additional 32", your decision could be made for you. Aside from the framing being plumb and level, the slope of the floor/deck is the next most important consideration. You want it to be as level as possible, but if there is a slope, you want the door to go from the higher point toward the lower area. You will have approximately 3/4" of play with the threshold. See illustrations in steps 11 - 15.

STEP 4: POSITION SLIPSTICK®

The Slipstick® should be positioned on the leading edge of the glide path direction. Secure with 1/2" color matched Tek screw.

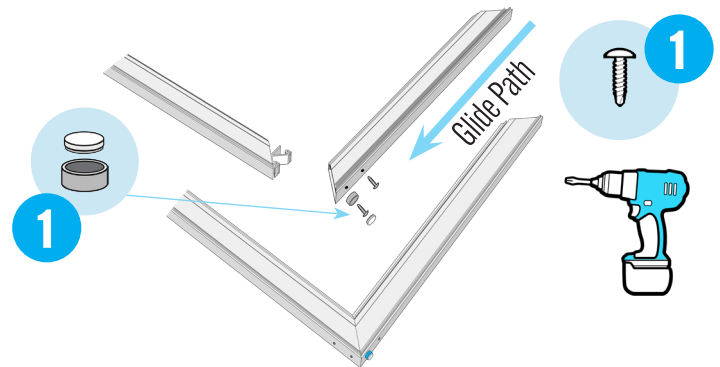

STEP 5: ASSEMBLE STILES & RAILS

Slide the stiles with corner keys into the rails on top and bottom. Make sure each corner is true and square. Install the 1/2" color matched Tek screws to secure each corner (read step 4 for Slipstick® position). Be sure the weatherstrip is pushed back so not to interfere with this step. The door should be secure at all four corners with the weatherstrip installed.

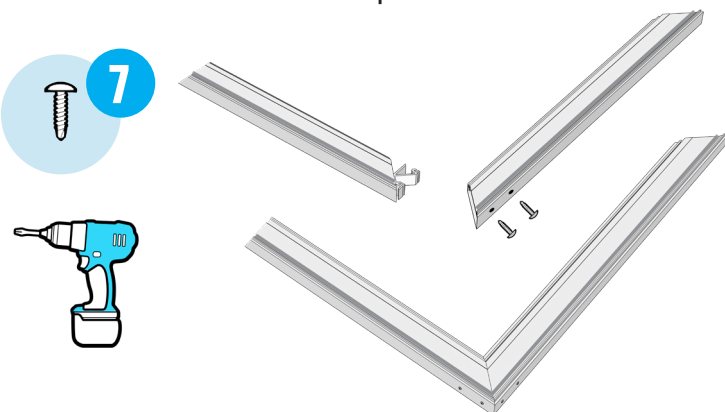

STEP 6: MEASURE & CUT VINYL CAPS

Cut vinyl caps at a **45 degree** angle.

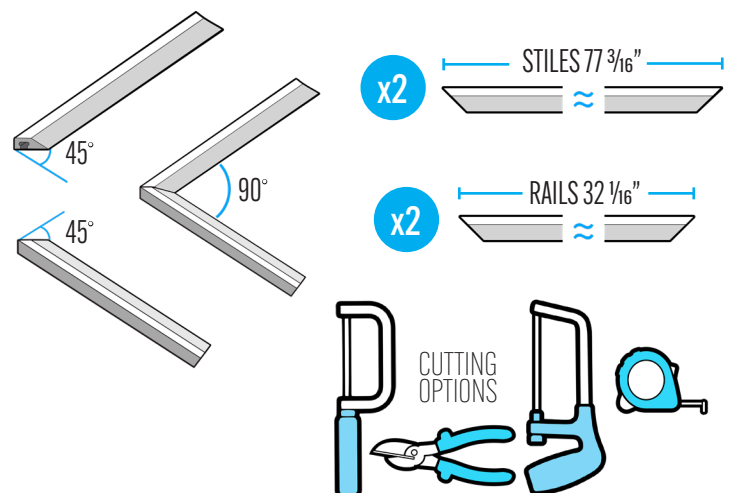

STEP 7: INSTALL SCREEN FABRIC

To avoid any damage to the stiles and rails of the door, keep the door on a solid level surface and use an intermediate wood block or tool to tap the vinyl cap on when securing the screen. Lay the screen over door opening. Square the screen on the door. Beginning on the pre-drilled rail (top of door) with the screen smooth and square, tap the vinyl cap onto the rib. Once it's secured to the rib, proceed to the center of that section and seat the vinyl cap completely moving from the center towards the corners. Make sure the screen has remained square on the frame. Gently pull the screen over the opposite side so there is no slack in the screen, but do not stretch it. Install the vinyl cap on the opposite side, then the ends in the same manner. Install the vinyl cap on top and bottom rails and then the stiles on each side.

The beveled side of the vinyl cap will face the screen opening.

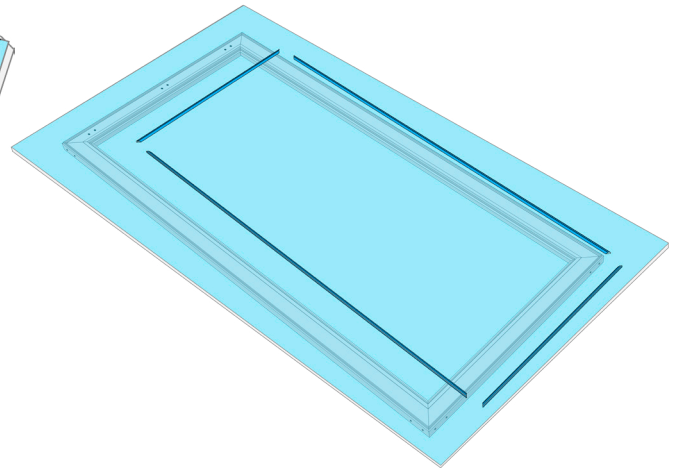
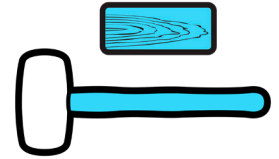
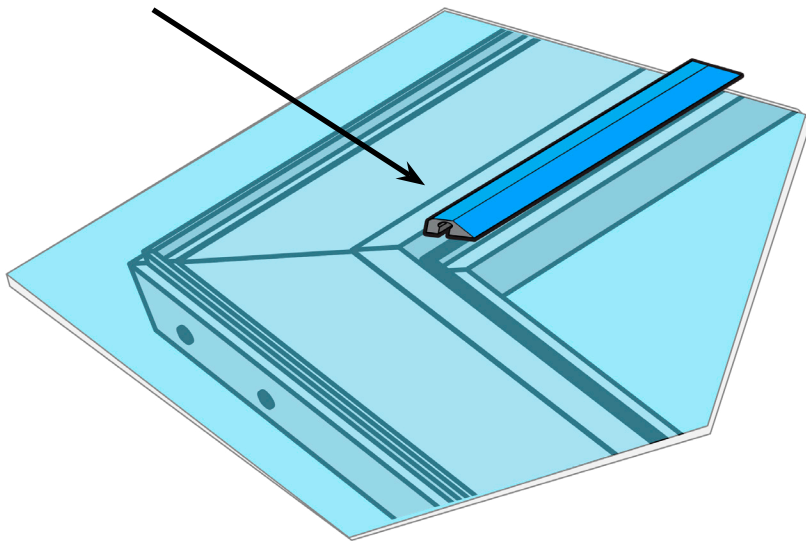

STEP 8: TRIM SCREEN

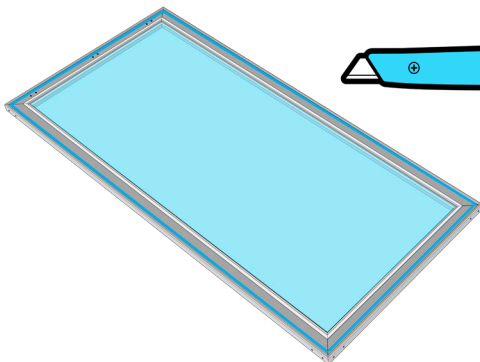

After checking to ensure the vinyl cap is secure, carefully use a razor knife to cut away excess screen fabric.

STEP 9: SEPARATE THE GLIDE BASE

Fully extend the glide to expose the release clip. Pinch to release and pull the ball bearing side off the base. Separate the door glide base and ball bearing side completely.

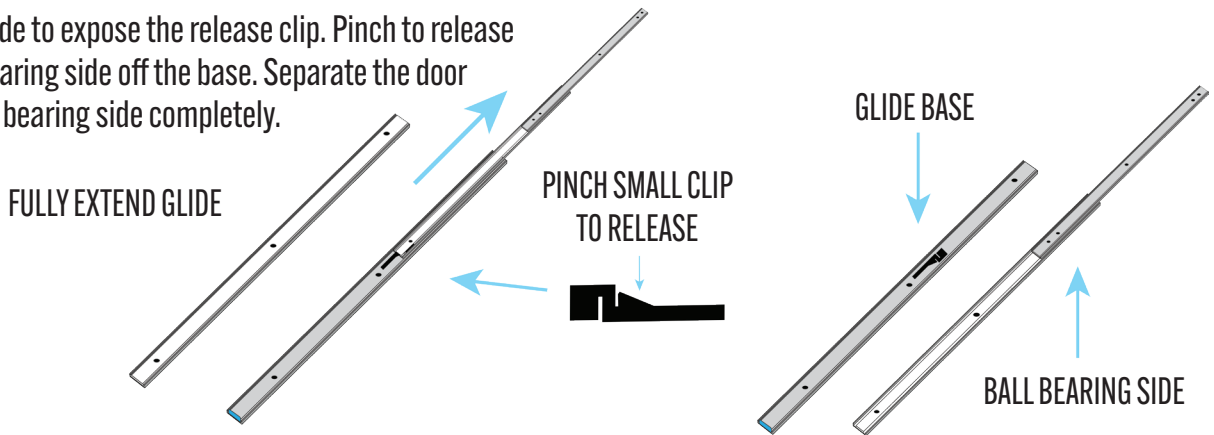

STEP 10: POSITION & SECURE BALL BEARING SIDE TO DOOR

Position the ball bearing side over the holes as indicated for a left glide or right glide. Extend glide to reveal holes. Secure with three 1/2" stainless steel Tek screws.

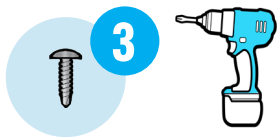

LEFT GLIDE ALIGNMENT AND ATTACHMENT

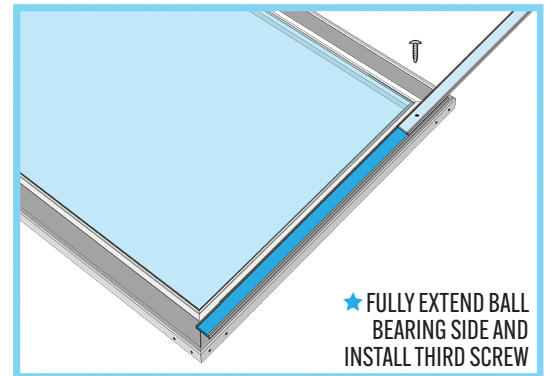
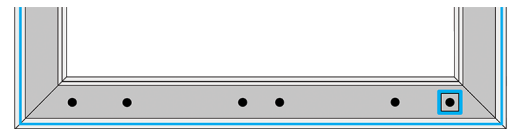
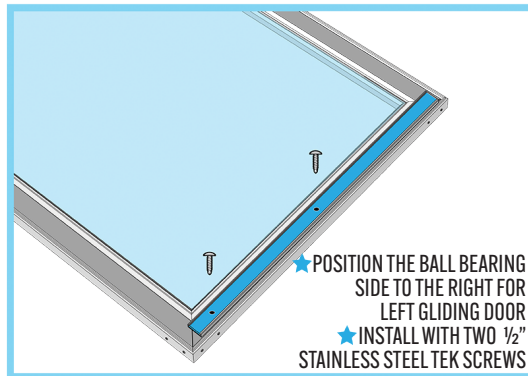

RIGHT GLIDE ALIGNMENT AND ATTACHMENT

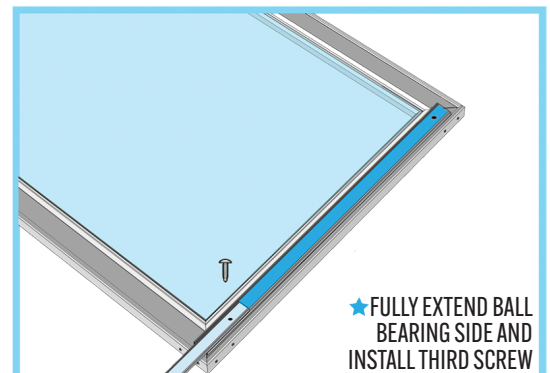
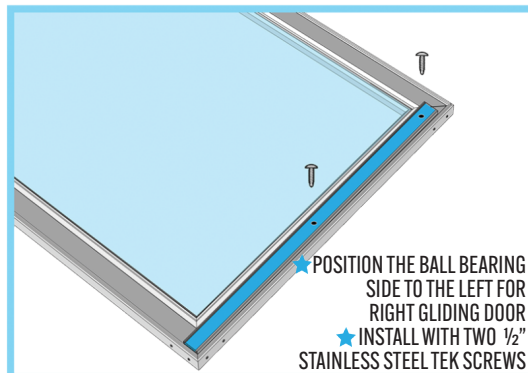
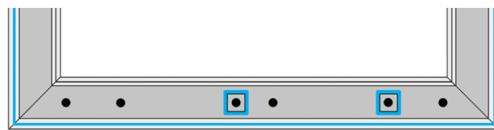

STEP 11: MEASURE & MARK FOR DOOR GLIDE BASE

The glide base must be perfectly flat on the header of your door opening. You can shim behind to keep it flat if necessary. It cannot bend at all. Measure as illustrated below and mark your horizontal and vertical lines. Measure both sides, you will follow the floor contour.

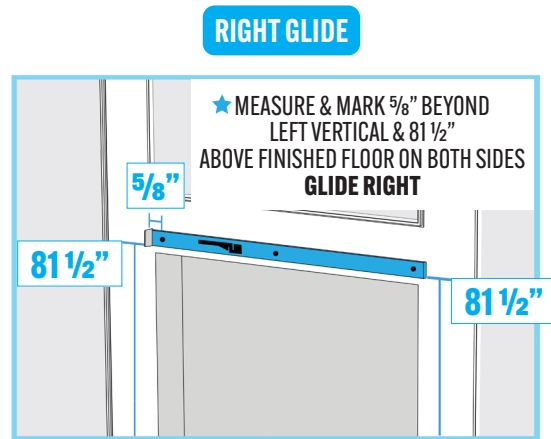
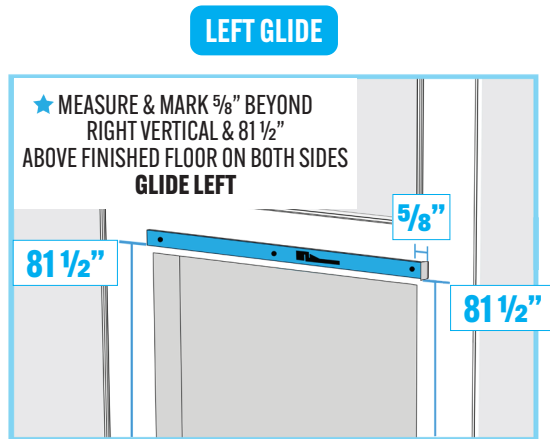

STEP 12: ATTACHING GLIDE TO TOP OF DOOR JAMB

Now that you have marked horizontal and vertical lines for the glide base you are ready to attach it to the door jamb.

1. Locate the vertical tab on the end of the glide base. For a left glide door (illustrated below) the tab will be to the right and will touch your marked line that extends beyond $\frac{5}{8}$ " vertical.
2. Position the glide base on the horizontal and vertical lines and mark three identical oval holes at the ends and center. Pre-drill a $\frac{3}{16}$ " pilot hole. Mark oval holes to accommodate slight adjustments if needed later.
3. Use three 1" stainless steel Tek screws to attach the glide base. Follow the floor contour using the $81\frac{1}{2}$ " measurement so that the track and floor are parallel.

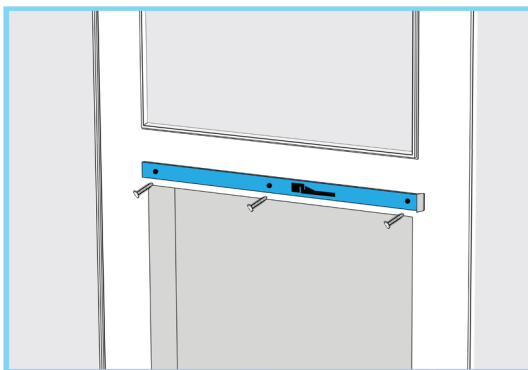
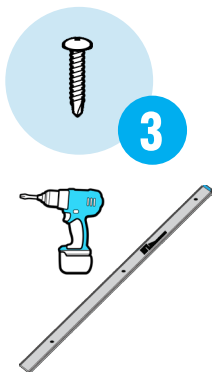

STEP 13: INSTALL 36" THRESHOLD

Install precut 36" threshold. This threshold does not receive weatherstripping. Use the three $1\frac{1}{4}$ " color matched screws and secure to finished floor.

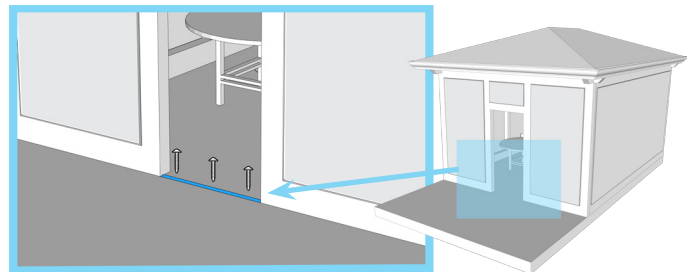
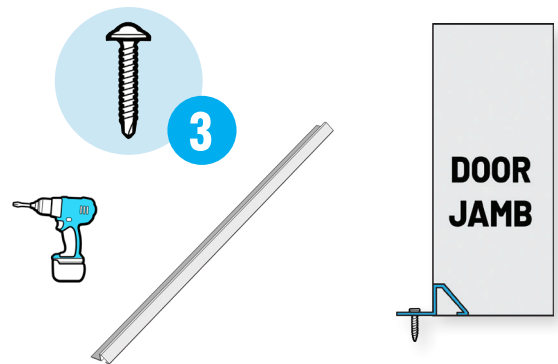

STEP 14: ALIGNING THE BALL BEARING GLIDE TO REASSEMBLE

Position the door to the side of the opening that will be its glide path. Extend the ball bearing side about 4-6". Align the ball bearing side so it will marry with the glide base and gently slide them together. Do not force this. If it doesn't go smoothly, something is out of alignment.

LEFT GLIDE

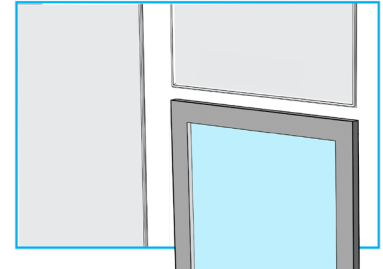
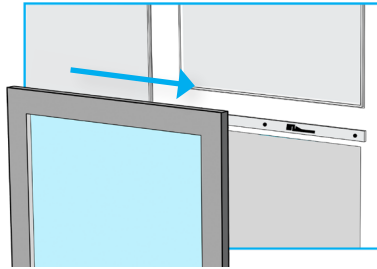
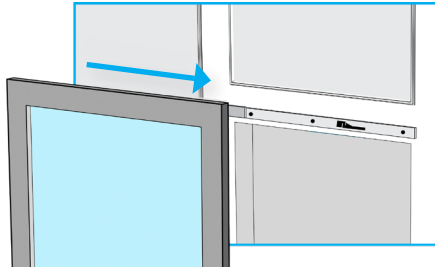

RIGHT GLIDE

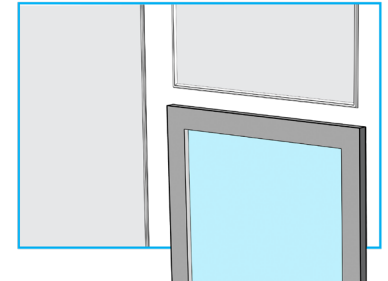
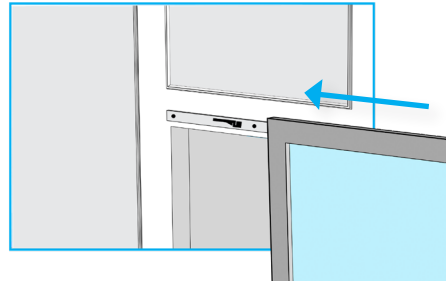
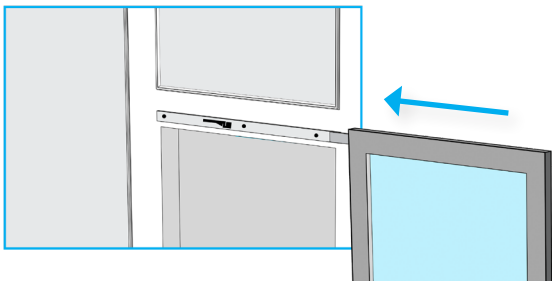

STEP 15: ADD WEATHERSTRIPPING ON 70" THRESHOLD & INSTALL WITH SCREWS

Remove backing from the self sticking weatherstrip and attach to the 70" threshold. With the door in the closed position, slide the threshold under the door until it makes contact with the door and the door shows an even margin all around the door frame. This is an important step that will ensure the door glides properly. The threshold should be approximately $1\frac{7}{8}$ " away from the door jamb on both sides. This measurement is a suggestion; every door opening is different.

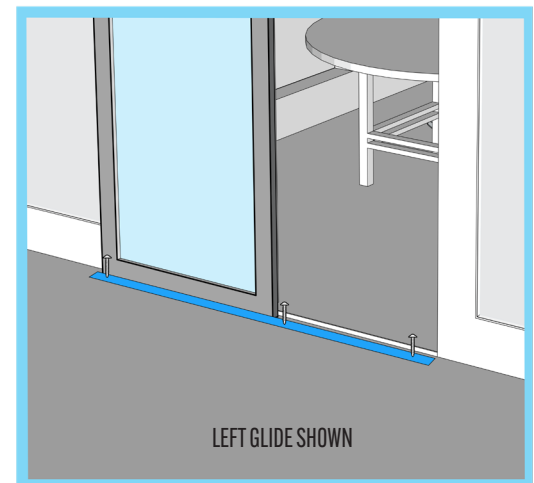
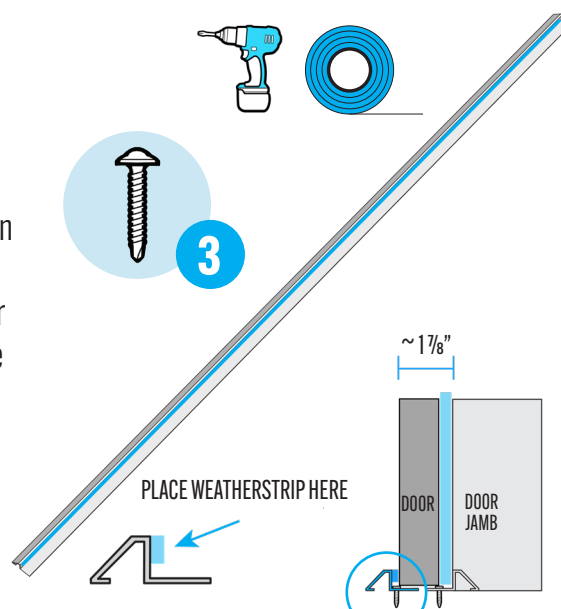

★ SCREW PLACEMENT SHOULD BE AS CLOSE TO WEATHERSTRIPPING AS POSSIBLE OR IT WILL INTERFERE WITH SLIPSTICK®

STEP 16: INSTALL DOOR STOPS

Install left and right door stops with 1 ¼" screws.

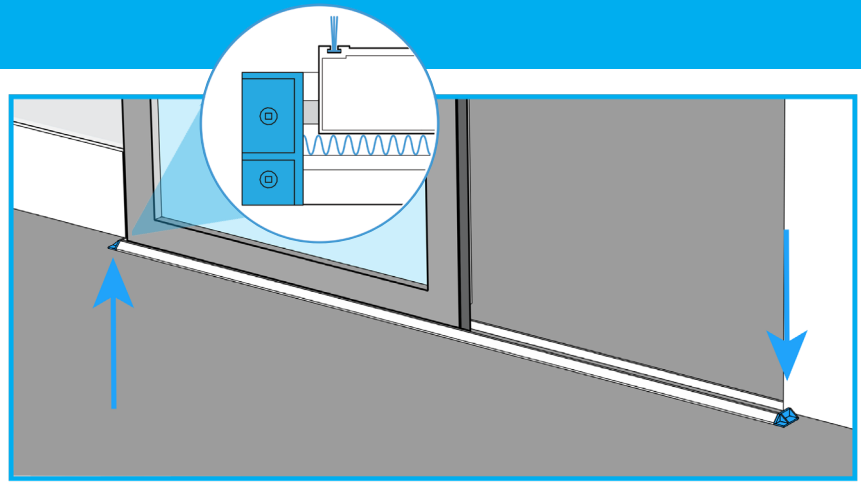
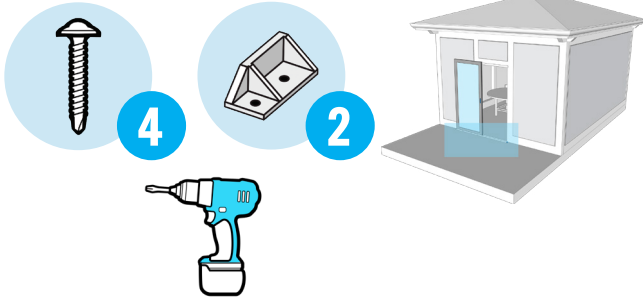

STEP 17: INSTALL DOOR HANDLES

Use included door pull template to install handles with the 1 ¼" color matched screws.

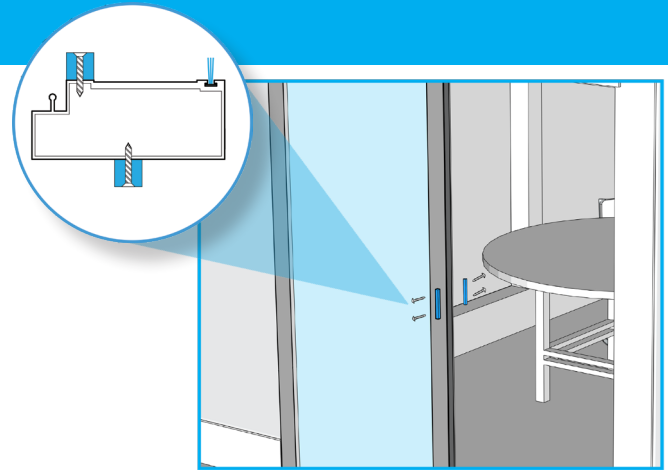
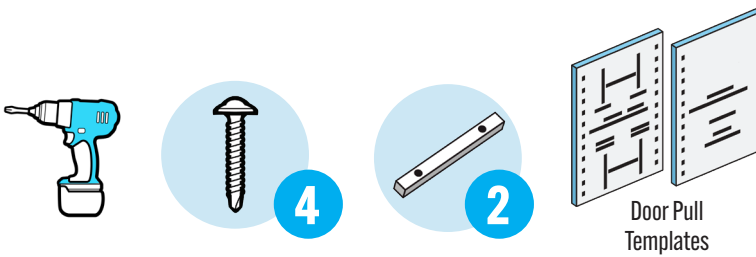

STEP 18: *OPTIONAL* SCREEN DOOR LATCH

Secure using four ½" stainless steel Tek screws.

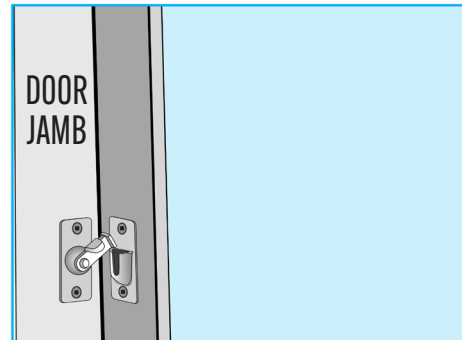

SCREENEZE® | SNAPTRACK
PLINTH | FLATBAR | WEDGE
THE SLIDING SCREEN DOOR

800.884.6697
www.SCREENEZE.com



SCAN FOR
MORE INFO

*Beautiful Bug-Free
Outdoor Spaces
Since 2003*